

**Mosaic™**  
**Multiple socket outlets, multisupport**  
**German standard**

Cat. No.: 0 772 52/53/54/72/73/74/81/82/83/90/91/92  
 0 792 82/83

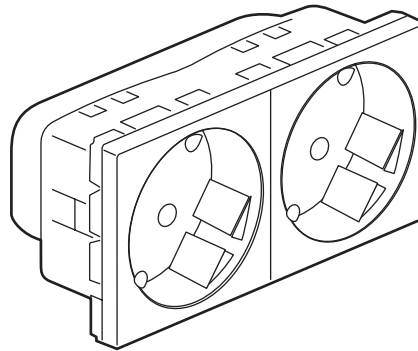

**1. USE**

2 to 4 gang german standard 45°-inclined multiple 16 A - 240 V~ socket outlets.  
 The outlets can be installed in flush mounting boxes, surface mounting frames, floor boxes, columns, multi-outlet extensions, office strips, etc.

**2. RANGE**

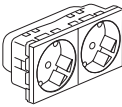
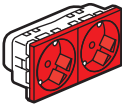
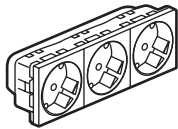
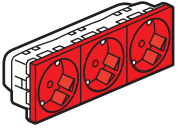
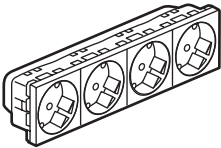
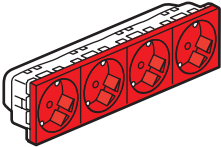
	Description	References
	2 x 2 P + E socket - 4 modules	0 772 92
	2 x 2 P + E socket with indicator - 4 modules	0 772 90
	2 x 2 P + E socket aluminium cover plate 4 modules	0 792 82
	2 x 2 P + E socket red cover plate	0 772 72
	2 x 2 P + E socket with indicator red cover plate	0 772 91
	2 x 2 P + E tamperproof socket - 4 modules	0 772 81
	2 x 2 P + E tamperproof socket with indicator 4 modules	0 772 92
	3 x 2 P + E socket 6 modules	0 772 53
	3 x 2 P + E socket aluminium cover plate 6 modules	0 792 83
	3 x 2 P + E socket red cover plate 6 modules	0 772 73
	3 x 2 P + E tamperproof socket 6 modules	0 772 82
	Prise 4 x 2 P + T 8 modules	0 772 84
	4 x 2 P + E socket red cover plate 8 modules	0 772 74
	4 x 2 P + E tamperproof socket 8 modules	0 772 83

**3. OVERALL DIMENSIONS (mm)**

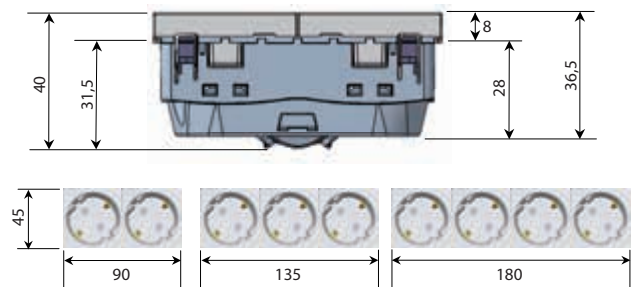

**4. CONNECTION**

Number of terminals: 3 inputs / 3 outputs (grey - green - grey)  
 Terminal type : automatic terminals  
 Terminal capacity: 1.5 mm<sup>2</sup> or 2.5 mm<sup>2</sup>  
 Wiring: flexible / rigid  
 Stripping length: 13 mm

**5. TECHNICAL DATA**

■ **5.1 Mechanical characteristics**

Impact resistance: IK 07  
 Protection against solid bodies and liquid: IP 40

■ **5.2 Material characteristics**

Cover plates: Polycarbonate  
 Bases: Acrylonitrile - Butadiene - Styrene

Self-extinguishing:

+ 850°C / 30 s for insulating components holding in place live parts.  
 + 650°C / 30 s for the other insulating components.

■ **5.3 Electrical characteristics**

Voltage: 240 V~  
 Current: 16 A

■ **5.4 Climatic characteristics**

Use and storage temperature: - 15° C to + 70° C

**6. CLEANING**

Surface cleaning using a cloth.

Do not use: acetone, tar remover, trichloroethylene.

Resistant to the following products:

- Hexane (EN 60669-1), methylated spirit, soapy water, diluted ammonia, 10% bleach solution, window cleaning products, moist towelettes.
- Anios, Surfanios, Bactilyline.

**Caution:** A preliminary test should be carried out if other specific cleaning products are to be used.

**7. ACCESSORIES**

Cat. No. 0 502 99: tamperproof insert for tamperproof sockets.

**8. STANDARDS AND APPROVALS**

Compliant with installation and manufacturing standards.

See e-catalogue.