



Symbolbild





## Datenblatt

**Artikelnummer:** 70006049

**Bezeichnung:** CA20B.A211.E

**Beschreibung:** Schalter

IEC 60947-3 EN 60947-3, VDE 0660 Teil 107							
<b>Bemessungsisolationsspannung Ui</b>							
<i>Spannung (V) AC / DC</i>							
690 AC / DC							
<b>Bemessungsdauerstrom Iu/Ith</b>							
<i>Strom (A)</i>	<i>Umgebungstemperatur (°C)</i>	<i>Temperaturspitzen (°C)</i>	<i>zusätzliche Bedingungen</i>				
25	55	60	Umgebungstemperatur +55°C über 24 Stunden mit Spitzen bis +60°C				
<b>Bemessungsbetriebsstrom Ie</b>							
<i>Gebrauchskategorie</i>							
<i>Spannung (V)</i>						<i>Strom (A)</i>	
AC-15						220 - 240	8
AC-15						380 - 440	5
<b>Bemessungsbetriebsleistung</b>							
<i>Gebrauchskategorie</i>	<i>Spannung (V)</i>	<i>Phasenanzahl</i>	<i>Polanzahl</i>	<i>Leistung (kW)</i>			
AC-3	220 - 240	3	3	4			
AC-3	380 - 440	3	3	7,50			
AC-3	660 - 690	3	3	7,50			
AC-3	220 - 240	1	2	3			
AC-3	380 - 440	1	2	3,70			
AC-23A	220 - 240	3	3	5,50			
AC-23A	380 - 440	3	3	11			
AC-23A	660 - 690	3	3	11			
AC-23A	220 - 240	1	2	3			
AC-23A	380 - 440	1	2	5,50			
<b>Max. Sicherungsnennstrom IEC</b>							
<i>Sicherungscharakteristik</i>							
<i>Sicherungsanzahl</i>						<i>Strom (A)</i>	
gG						1	35
<b>UL60947-4-1 , UL508</b>							
<b>Nominal Voltage</b>							
<i>Spannung (V) AC / DC</i>							
600 AC							
<b>Bemessungsisolationsspannung Ui</b>							
<i>Spannung (V) AC / DC</i>							
600 AC							
<b>Rated thermal current</b>							
<i>Strom (A)</i>							
30							
<i>Umgebungstemperatur (°C) Zusatz Text</i>							
0 - 40 --							
<b>Horsepower rating</b>							
<i>Across-the-Line Motor Starting</i>							
	<i>Spannung (V)</i>	<i>Phasenanzahl</i>	<i>Polanzahl</i>	<i>Leistung (HP)</i>	<i>Umgebungstemperatur [°C]</i>		
Reversing	110 - 120	1	2	0,33	40		
Reversing	220 - 240	1	2	0,75	40		
Reversing	277 - 277	1	2	1	40		
Reversing	415 - 415	1	2	1,50	40		
Reversing	440 - 480	1	2	2	40		
Reversing	550 - 600	1	2	2	40		
Reversing	110 - 120	3	3	1	40		
Reversing	220 - 240	3	3	2	40		
Reversing	415 - 415	3	3	3	40		
Reversing	440 - 480	3	3	5	40		
Reversing	550 - 600	3	3	5	40		
DOL	110 - 120	1	2	1,50	40		
DOL	220 - 240	1	2	3	40		
DOL	277 - 277	1	2	3	40		
DOL	415 - 415	1	2	3	40		
DOL	440 - 480	1	2	5	40		
DOL	550 - 600	1	2	5	40		
DOL	110 - 120	3	3	3	40		
DOL	220 - 240	3	3	7,50	40		
DOL	415 - 415	3	3	7,50	40		
DOL	440 - 480	3	3	10	40		
DOL	550 - 600	3	3	10	40		

<b>Pilot duty rating code</b>						
Duty Code						
A600						
<b>SCCR / Max. Versicherung</b>						
Conditions of acceptability						
These devices are suitable for use on circuits capable of delivering not more than 5000 rms symmetrical amperes, 600V ac max. when protected by Class RK1 fuses. Manual Motor Controllers when intended for use as a motor disconnecter are suitable for use on a circuit capable of delivering not more than 5000 rms symmetrical amperes, 600V ac max. when protected by 30A Class J time delay fuses.						
<b>Temp. rating of wire</b>						
Temperature Rating (°C)			Strom (A) Text			
75			– Use copper wire only			
<b>Anschlussbestimmungen</b>						
Markings						
When intended for use as a motor disconnecter the device shall be provided with a method of being locked in the OFF-position.						
<b>General Use</b>						
AC / DC	Spannung (V)	Strom (A)	Phasenanzahl	Polanzahl	Anzahl der Kontakte in Serie	
AC	600	30	1	2	1	
AC	600	30	3	3	1	
<b>CSA</b>						
<b>Nominal Voltage</b>						
			Spannung (V) AC / DC			
			600 AC			
<b>Bemessungsisolationsspannung Ui</b>						
			Spannung (V) AC / DC			
			600 AC			
<b>Rated thermal current</b>						
		Strom (A)		Umgebungstemperatur (°C) Zusatz Text		
		30		0 - 40 –		
<b>Horsepower rating</b>						
Across-the-Line Motor Starting		Spannung (V)	Phasenanzahl	Polanzahl	Leistung (HP)	Umgebungstemperatur [°C]
DOL		110 - 120	1	2	1,50	40
DOL		220 - 240	1	2	3	40
DOL		277 - 277	1	2	3	40
DOL		415 - 415	1	2	5	40
DOL		440 - 480	1	2	5	40
DOL		550 - 600	1	2	5	40
DOL		110 - 120	3	3	3	40
DOL		220 - 240	3	3	7,50	40
DOL		415 - 415	3	3	10	40
DOL		440 - 480	3	3	10	40
DOL		550 - 600	3	3	10	40
<b>Pilot duty rating code</b>						
Duty Code						
A600						
<b>Temp. rating of wire</b>						
Temperature Rating (°C)			Strom (A) Text			
75			– only			
<b>General Use</b>						
AC / DC	Spannung (V)	Strom (A)	Phasenanzahl	Polanzahl	Anzahl der Kontakte in Serie	
AC	600	30	1	1	1	
<b>GENERAL TECHNICAL INFORMATION</b>						
<b>Leiterquerschnitt</b>						
Leiteraufbau	Min. / Max. Wert	Anzahl der Leiter pro Klemme		Drahtquerschnitt (-bereich) (mm <sup>2</sup> ) oder (AWG/kcmil)	Drahtmaterial	
feindrähtig	Max.			2 AWG 12	Kupfer	
feindrähtig	Max.			2 4mm <sup>2</sup>	Kupfer	
ein- bzw. mehrdrähtig	Max.			2 AWG 10	Kupfer	
ein- bzw. mehrdrähtig	Max.			2 4mm <sup>2</sup>	Kupfer	
feindrähtig mit Aderendhülsen nach DIN 46228	Max.			2 2,5mm <sup>2</sup>	Kupfer	
<b>Abisolierlänge des Leiters</b>						
			Länge (mm)	Anschlusslänge - Bild		
						
<b>Empfohlene Schraubendreher</b>						
Schraubendreherart			Wert			
Kreuzschlitz - Schraubendreher			PH1			
Schlitzschraubendreher nach DIN 5264			0,8x5,5			
<b>Klemmschraube</b>						
			Anzugsdrehmoment (Nm)		Anzugsdrehmoment (lb-in)	
			1		9	
<b>Approbationen</b>						
Specification					Marking	
EAC						
CE marking						
UK Directives						

**Approbationen** Marking

Specification

CSA C.22.2 No.14



GB/T14048.3



**Allgemeine Informationen**

Text

- Die Schaltgeräte sind wartungsfrei. Schmierung oder Behandlung von Kontakten ist zu unterlassen.
- Die Schalter dürfen nur von Fachkräften und nach den anerkannten Regeln der Technik eingebaut, angeschlossen und in Betrieb genommen werden.
- Nur Kupferleitungen verwenden. Leiterenden nicht verzinnen.
- Klemmen mit werksseitig angeschlossenen Verbindungslaschen bzw. Drahtverbindungen werden verschraubt geliefert. Nach dem Öffnen solcher Klemmen ist darauf zu achten, dass keine Verbindungslaschen verloren gehen, alle Drahtverbindungen wieder korrekt sitzen und die Klemmschrauben mit dem angegebenen Drehmoment wieder festgezogen werden.
- Nach Installation der Schalter müssen die Kriech- und Luftstrecken im Bereich der Anschlussklemmen den Anforderungen der anwendbaren Norm und Vorschriften entsprechen.

**Waste Electrical & Electronic Equipment (WEEE)**

Picture name

Description

 Nicht in den Müll werfen, da auf eine umweltgerechte Entsorgung und Wiederverwertung geachtet werden muss. Bitte wenden Sie sich entweder an ein umweltfreundliches Entsorgungsunternehmen; senden Sie es zur Entsorgung an den Lieferanten oder direkt an den Hersteller Kraus & Naimer zurück. Lokale Kraus & Naimer Ansprechpartner finden Sie unter [www.krausnaimer.com](http://www.krausnaimer.com)

**Proposition 65**

Bildname

Beschreibung

 WARNING: This product can expose you to chemicals including nickel and lead, which is known to the State of California to cause cancer. For more information go to [www.P65Warnings.ca.gov](http://www.P65Warnings.ca.gov).

Kontakttype: Starre Kontaktbrücke

Kontaktmaterial: Silber

Anschluss: Schraubanschluss

**Bauform-E**

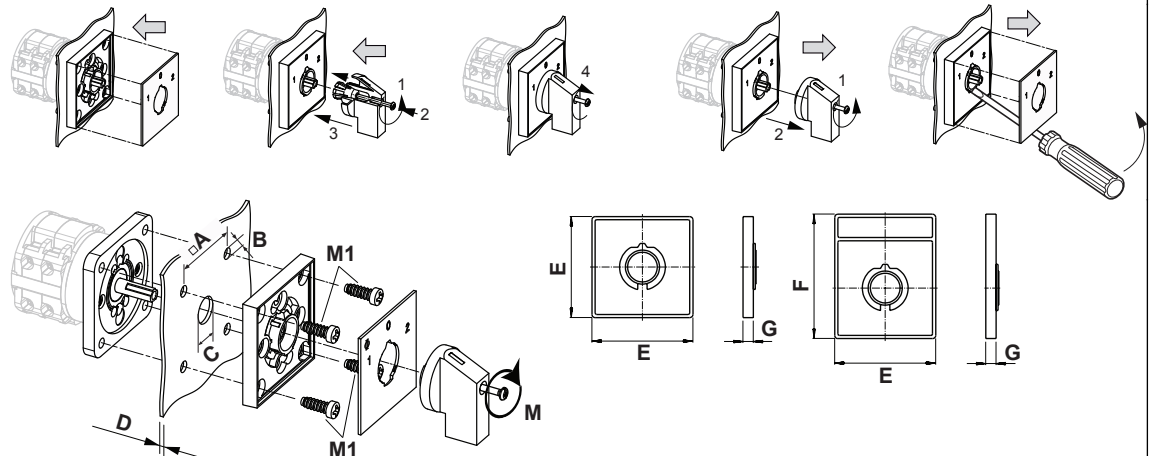

IP - Schutzart Front		IP40
Fluchten		1,00 - 12,00
A	□	48,00 mm
B	∅	5,00 mm
C	∅	10,00 - 22,00 mm
D	H	<= 4,00 mm
E	H	64,00 mm
F	H	78,00 mm
G	H	7,40 mm
M	$\vec{m}$	0,70 Nm
M1	$\vec{m}$	0,90 Nm

## Anschlussbild

CA20B.A211.E

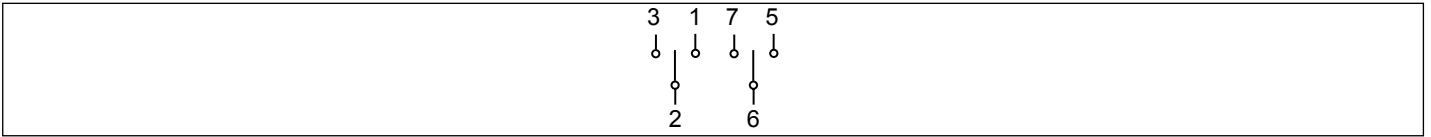

# Schaltprogramm

CA20B.A211.E

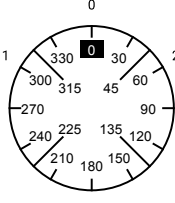
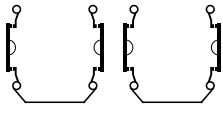
 Kraus & Naimer		<b>CA20B</b>	<b>A211</b>	<b>Seite 1 von 1</b>											
<b>Frontschild</b>															
		1	3	5	7	9	11	13	15	17	19	21	23		
															
Schaltwinkel <input type="text" value="60"/>		2	4	6	8	10	12	14	16	18	20	22	24		
Gesamtschaltwinkel <input type="text" value="120"/>															
1	300		■		■										
	315														
	330														
	345														
0	0														
	15														
	30														
	45														
2	60	■		■											
	75														
	90														
	105														
	120														
	135														
	150														
	165														
	180														
	195														
	210														
	225														
	240														
	255														
	270														
	285														

Version: 112

**Frontschild**

S1.F071/A1B.PEL

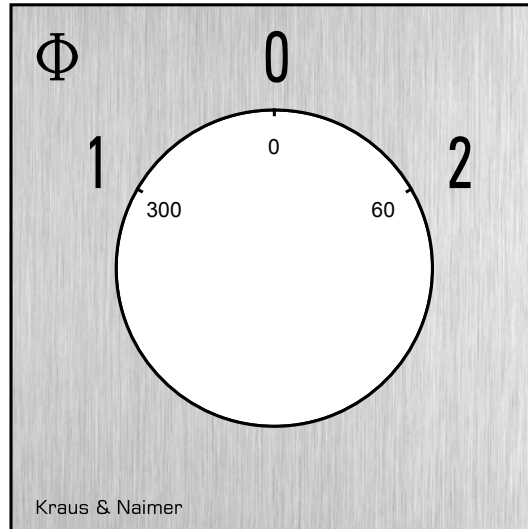

## GRIFFE

**Bezeichnung:** S1B.G251

**Grifffarbe:** "1" schwarz

