

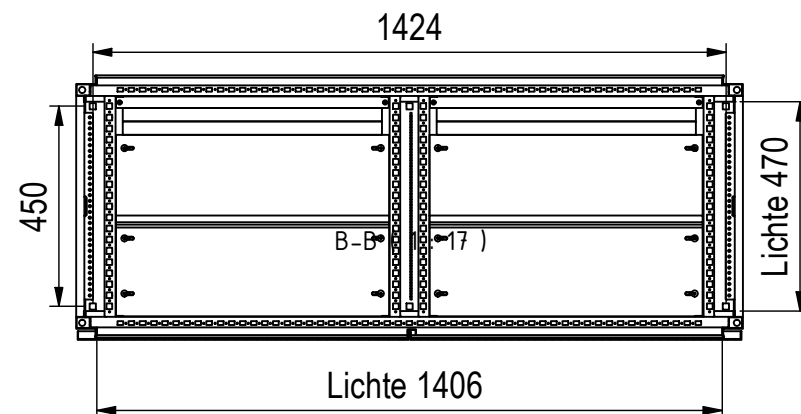

Bodenbefestigung □14mm



1	TSRM Flansch	FL-F-U_1_TSRM
1	TSRM Dachblech	DB-F_600
1	TSRM Tuer	TUER-T-F12-R
1	TSRM Tuer	TUER-T-F12-L
4	Montageprofil	MZ-1_600
ANZAHL	BESCHREIBUNG	ARTIKEL
ABGEBILDETE BAUTEILE		

 <b>MEHLER</b> ELEKTROTECHNIK	orig. Blattgr: A3 gezeichnet	<b>Mat:</b> Elo 1,5-2,0 mm	<b>Oberfläche:</b> RAL 7035	<b>Gewicht:</b> -
	17.01.2024 F.Hiemesch	<b>Bezeichnung:</b> TSRM-F_600_12		<b>ENG-000005334</b>
Dateiname: C:\_JPTemp\Daten\Daten\TSRM\Standardschraenke\TSRM-F\ENG-000005293.iam				<small>Schutzvermerk nach DIN ISO 16016 © Firma MEHLER Elektrotechnik Ges.m.b.H</small>