

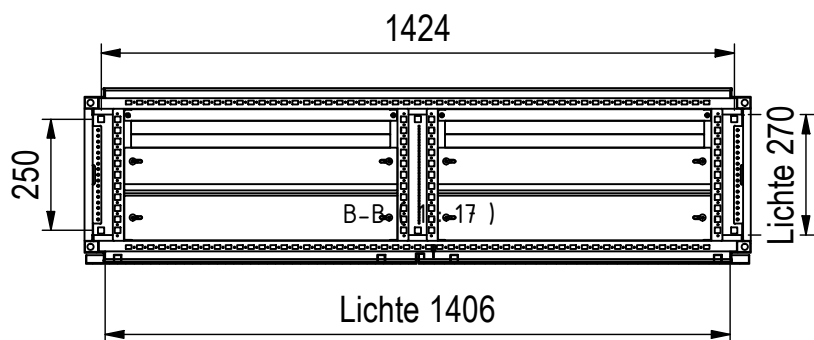

Bodenbefestigung □14mm



1	TSRM Flansch	FL-F-U_1_TSRM
1	TSRM Dachblech	DB-F_400
1	TSRM Tuer	TUER-T-F18-R
1	TSRM Tuer	TUER-T-F18-L
4	Montageprofil	MZ-1_400
ANZAHL	BESCHREIBUNG	ARTIKEL
ABGEBILDETE BAUTEILE		

 MEHLER ELEKTROTECHNIK	orig. Blattgr: A3 gezeichnet	Mat: Elo 1,5-2,0 mm	Oberfläche: RAL 7035	Gewicht: -
	17.01.2024 F.Hiemesch	Bezeichnung: TSRM-F_400_18		ENG-000005325
Dateiname: C:_JPTemp\Daten\Daten\TSRM\Standardschraenke\TSRM-F\ENG-000005301.iam				<small>Schutzvermerk nach DIN ISO 16016 © Firma MEHLER Elektrotechnik Ges.m.b.H</small>