

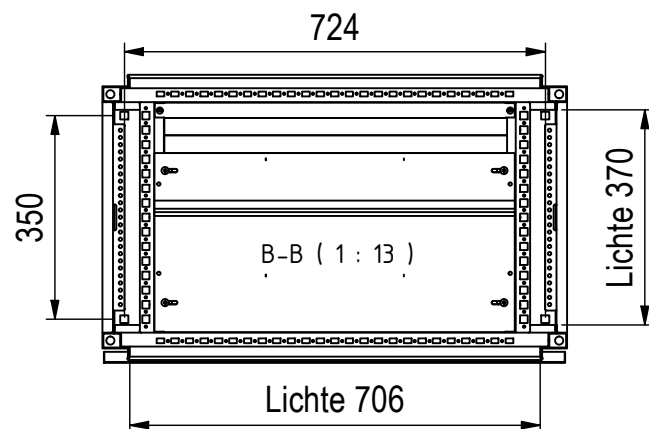

Bodenbefestigung □14mm



1	TSRM Flansch	FL-C-U_1_TSRM
1	TSRM Tuer	TUER-T-C14
1	TSRM Dachblech	DB-C_500
4	Montageprofil	MZ-1_500
ANZAHL	BESCHREIBUNG	ARTIKEL
ABGEBILDETE BAUTEILE		

	orig. Blattgr: A3 gezeichnet	Mat:Elo 1,5-2,0 mm	Oberfläche: RAL 7035	Gewicht: 53,5 kg
	11.01.2024 F.Hiemesch	Bezeichnung: TSRM-C_500_14		ENG-000004629
Dateiname: C:_JPTemp\Daten\Daten\TSRM\Standardschraenke\TSRM-C\ENG-000004311.iam				<small>Schutzvermerk nach DIN ISO 16016 © Firma MEHLER Elektrotechnik Ges.m.b.H</small>