



Symbolbild





Datenblatt

Artikelnummer: 70014574

Bezeichnung: CH10.A215.E

Beschreibung: Schalter

IEC 60947-3 EN 60947-3, VDE 0660 Teil 107						
Bemessungsisolationsspannung Ui						
Spannung (V) AC / DC						
690 AC / DC						
Bemessungsdauerstrom Iu/Ith						
Strom (A)	Umgebungstemperatur (°C)	Temperaturspitzen (°C)	zusätzliche Bedingungen			
20	55	60	Umgebungstemperatur +55°C über 24 Stunden mit Spitzen bis +60°C			
Bemessungsbetriebsstrom Ie						
Gebrauchskategorie						Strom (A)
AC-15						220 - 240 6
AC-15						380 - 440 4
Bemessungsbetriebsleistung						
Gebrauchskategorie	Spannung (V)	Phasenanzahl	Polanzahl	Leistung (kW)		
AC-3	220 - 240	3	3	3		
AC-3	380 - 440	3	3	5,50		
AC-3	660 - 690	3	3	5,50		
AC-3	220 - 240	1	2	2,20		
AC-3	380 - 440	1	2	3		
AC-23A	220 - 240	3	3	3,70		
AC-23A	380 - 440	3	3	7,50		
AC-23A	660 - 690	3	3	7,50		
AC-23A	220 - 240	1	2	2,50		
AC-23A	380 - 440	1	2	3,70		
Maximaler Sicherungsnennstrom IEC						
Sicherungscharakteristik						Strom (A)
gG						Sicherungsanzahl 1 25
UL60947-4-1 , UL508						
Nominal Voltage						
Spannung (V) AC / DC						
600 AC						
Bemessungsisolationsspannung Ui						
Spannung (V) AC / DC						
600 AC						
Rated thermal current						
Strom (A)						Umgebungstemperatur (°C) Zusatz Text
20						0 - 40 --
Horsepower rating						
<i>Across-the-Line Motor Starting</i>						
	Spannung (V)	Phasenanzahl	Polanzahl	Leistung (HP)	Umgebungstemperatur [°C]	
DOL	110 - 120	1	2	0,50	40	
DOL	220 - 240	1	2	1	40	
DOL	277 - 277	1	2	2	40	
DOL	440 - 480	1	2	2	40	
DOL	550 - 600	1	2	2	40	
DOL	110 - 120	3	3	1,50	40	
DOL	220 - 240	3	3	3	40	
DOL	440 - 480	3	3	5	40	
DOL	550 - 600	3	3	5	40	
Pilot duty rating code						
Duty Code						
A600						
SCCR / Max. Vorsicherung						
Conditions of acceptability						
These devices are suitable for use on circuits capable of delivering not more than 5kA rms symmetrical amperes, 600V ac max. when protected by Class RK1 fuses.						
Temp. rating of wire						
Temperature Rating (°C)						Strom (A) Text
60 - 75						-- Use copper wire only
General Use						
AC / DC	Spannung (V)	Strom (A)	Phasenanzahl	Polanzahl	Anzahl der Kontakte in Serie	
AC	277	20	1	1	1	
AC	600	20	1	2	1	

General Use						
AC / DC	Spannung (V)	Strom (A)	Phasenanzahl	Polanzahl	Anzahl der Kontakte in Serie	
AC	600	20	3	3	1	
CSA						
Nominal Voltage						
				Spannung (V)	AC / DC	
				600	AC	
Bemessungsisolationsspannung UI						
				Spannung (V)	AC / DC	
				600	AC	
Rated thermal current						
		Strom (A)	Umgebungstemperatur (°C)		Zusatz Text	
		20	0 - 40		-	
Horsepower rating						
Across-the-Line Motor Starting	Spannung (V)	Phasenanzahl	Polanzahl	Leistung (HP)	Umgebungstemperatur [°C]	
DOL	110 - 120	1	2	0,50	40	
DOL	220 - 240	1	2	1	40	
DOL	277 - 277	1	2	2	40	
DOL	440 - 480	1	2	2	40	
DOL	550 - 600	1	2	2	40	
DOL	110 - 120	3	3	1,50	40	
DOL	220 - 240	3	3	3	40	
DOL	440 - 480	3	3	5	40	
DOL	550 - 600	3	3	5	40	
Pilot duty rating code						
Duty Code						
A600						
Temp. rating of wire						
			Temperature Rating (°C)	Strom (A) Text		
			75	-- --		
General Use						
AC / DC	Spannung (V)	Strom (A)	Phasenanzahl	Polanzahl	Anzahl der Kontakte in Serie	
AC	277	20	1	1	1	
AC	600	20	1	2	1	
AC	600	20	3	3	1	
GENERAL TECHNICAL INFORMATION						
Klemmschraube						
			Anzugsdrehmoment (Nm)	Anzugsdrehmoment (lb-in)		
			1	9		
Abisolierlänge des Leiters						
		Länge (mm)	Anschlusslänge - Bild			
		9	STRIPPINGLENGTH			
Leiterquerschnitt						
Leiteraufbau	Min. / Max. Wert	Anzahl der Leiter pro Klemme	Drahtquerschnitt (-bereich) (mm ²) oder (AWG/kcmil)		Drahtmaterial	
eindräftig	Min.	1	0,75mm ²		Kupfer	
eindräftig	Min.	2	0,75mm ²		Kupfer	
feindräftig	Min.	1	0,75mm ²		Kupfer	
feindräftig	Min.	2	0,75mm ²		Kupfer	
feindräftig	Max.	2	AWG 12		Kupfer	
feindräftig	Max.	2	2,5mm ²		Kupfer	
ein- bzw. mehrdräftig	Max.	2	AWG 10		Kupfer	
ein- bzw. mehrdräftig	Max.	2	4mm ²		Kupfer	
feindräftig mit Aderendhülsen nach DIN 46228	Min.	1	0,75mm ²		Kupfer	
feindräftig mit Aderendhülsen nach DIN 46228	Min.	2	0,75mm ²		Kupfer	
feindräftig mit Aderendhülsen nach DIN 46228	Max.	2	2,5mm ²		Kupfer	
Approbationen						
Specification					Marking	
EAC						
CE marking						
UK Directives						
CSA C.22.2 No.14						
GB/T14048.3						
Empfohlene Schraubendreher						
Schraubendreherart				Wert		
Kreuzschlitz - Schraubendreher				PH1		
Schlitzschraubendreher nach DIN 5264				0,8x4		
Allgemeine Informationen						
Text						
- Die Schaltgeräte sind wartungsfrei. Schmierung oder Behandlung von Kontakten ist zu unterlassen.						

Allgemeine Informationen

Text

- Die Schalter dürfen nur von Fachkräften und nach den anerkannten Regeln der Technik eingebaut, angeschlossen und in Betrieb genommen werden.
- Nur Kupferleitungen verwenden. Leiterenden nicht verzinnen.
- Klemmen mit werksseitig angeschlossenen Verbindungsfaschen bzw. Drahtverbindungen werden verschraubt geliefert. Nach dem Öffnen solcher Klemmen ist darauf zu achten, dass keine Verbindungsfaschen verloren gehen, alle Drahtverbindungen wieder korrekt sitzen und die Klemmschrauben mit dem angegebenen Drehmoment wieder festgezogen werden.
- Nach Installation der Schalter müssen die Kriech- und Luftstrecken im Bereich der Anschlussklemmen den Anforderungen der anwendbaren Norm und Vorschriften entsprechen.

Waste Electrical & Electronic Equipment (WEEE)

Picture name

Description



Nicht in den Müll werfen, da auf eine umweltgerechte Entsorgung und Wiederverwertung geachtet werden muss. Bitte wenden Sie sich entweder an ein umweltfreundliches Entsorgungsunternehmen; senden Sie es zur Entsorgung an den Lieferanten oder direkt an den Hersteller Kraus & Naimer zurück. Lokale Kraus & Naimer Ansprechpartner finden Sie unter www.krausnaimer.com

Proposition 65

Bildname

Beschreibung



WARNING: This product can expose you to chemicals including nickel and lead, which is known to the State of California to cause cancer. For more information go to www.P65Warnings.ca.gov.

Kontakttype: Starre Kontaktbrücke

Kontaktmaterial: Silber

Anschluss: Schraubanschluss

Bauform-E

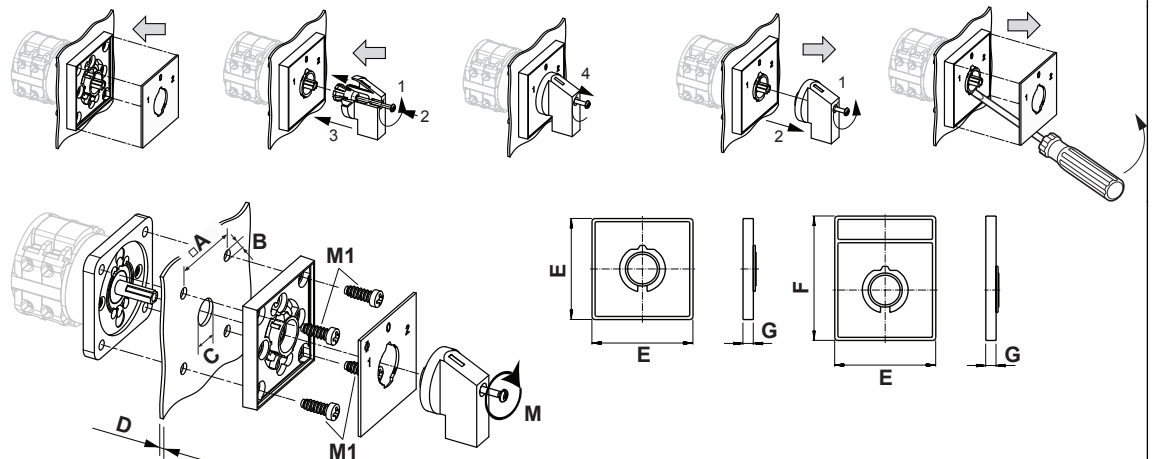

IP - Schutzart Front		IP40
Fluchten		1,00 - 12,00
A	□	36,00 mm
B	∅	5,00 mm
C	∅	8,00 - 19,00 mm
D	H	<= 4,00 mm
E	H	48,00 mm
F	H	59,00 mm
G	H	6,70 mm
M	M̄	0,50 Nm
M1	M̄	0,90 Nm

Anschlussbild

CH10.A215.E

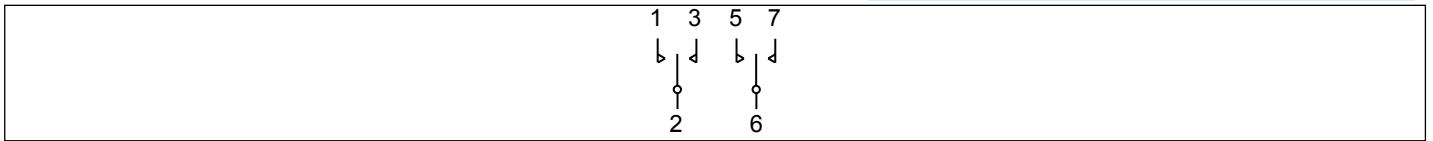

Schaltprogramm

CH10.A215.E

 Kraus & Naimer

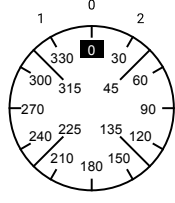
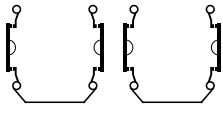
	CH10	A215	Seite 1 von 1																																																																																																																																																																																																																																																																																																																																	
Frontschild																																																																																																																																																																																																																																																																																																																																				
	1	3	5	7	9	11	13	15	17	19	21	23																																																																																																																																																																																																																																																																																																																								
																																																																																																																																																																																																																																																																																																																																				
Schaltwinkel <input type="text" value="30"/>	2	4	6	8	10	12	14	16	18	20	22	24																																																																																																																																																																																																																																																																																																																								
Gesamtschaltwinkel <input type="text" value="60"/>																																																																																																																																																																																																																																																																																																																																				
<table border="1" style="border-collapse: collapse;"> <tr><td style="width: 20px;">1</td><td style="width: 50px;">330</td><td style="width: 15px;">■</td><td></td><td style="width: 15px;">■</td><td></td><td></td><td></td><td></td><td></td><td></td><td></td><td></td></tr> <tr><td></td><td>345</td><td></td><td></td><td></td><td></td><td></td><td></td><td></td><td></td><td></td><td></td><td></td></tr> <tr><td style="text-align: center;">0</td><td>0</td><td></td><td></td><td></td><td></td><td></td><td></td><td></td><td></td><td></td><td></td><td></td></tr> <tr><td></td><td>15</td><td></td><td></td><td></td><td></td><td></td><td></td><td></td><td></td><td></td><td></td><td></td></tr> <tr><td style="text-align: center;">2</td><td>30</td><td style="text-align: center;">■</td><td></td><td style="text-align: center;">■</td><td></td><td></td><td></td><td></td><td></td><td></td><td></td><td></td></tr> <tr><td></td><td>45</td><td></td><td></td><td></td><td></td><td></td><td></td><td></td><td></td><td></td><td></td><td></td></tr> <tr><td></td><td>60</td><td></td><td></td><td></td><td></td><td></td><td></td><td></td><td></td><td></td><td></td><td></td></tr> <tr><td></td><td>75</td><td></td><td></td><td></td><td></td><td></td><td></td><td></td><td></td><td></td><td></td><td></td></tr> <tr><td></td><td>90</td><td></td><td></td><td></td><td></td><td></td><td></td><td></td><td></td><td></td><td></td><td></td></tr> <tr><td></td><td>105</td><td></td><td></td><td></td><td></td><td></td><td></td><td></td><td></td><td></td><td></td><td></td></tr> <tr><td></td><td>120</td><td></td><td></td><td></td><td></td><td></td><td></td><td></td><td></td><td></td><td></td><td></td></tr> <tr><td></td><td>135</td><td></td><td></td><td></td><td></td><td></td><td></td><td></td><td></td><td></td><td></td><td></td></tr> <tr><td></td><td>150</td><td></td><td></td><td></td><td></td><td></td><td></td><td></td><td></td><td></td><td></td><td></td></tr> <tr><td></td><td>165</td><td></td><td></td><td></td><td></td><td></td><td></td><td></td><td></td><td></td><td></td><td></td></tr> <tr><td></td><td>180</td><td></td><td></td><td></td><td></td><td></td><td></td><td></td><td></td><td></td><td></td><td></td></tr> <tr><td></td><td>195</td><td></td><td></td><td></td><td></td><td></td><td></td><td></td><td></td><td></td><td></td><td></td></tr> <tr><td></td><td>210</td><td></td><td></td><td></td><td></td><td></td><td></td><td></td><td></td><td></td><td></td><td></td></tr> <tr><td></td><td>225</td><td></td><td></td><td></td><td></td><td></td><td></td><td></td><td></td><td></td><td></td><td></td></tr> <tr><td></td><td>240</td><td></td><td></td><td></td><td></td><td></td><td></td><td></td><td></td><td></td><td></td><td></td></tr> <tr><td></td><td>255</td><td></td><td></td><td></td><td></td><td></td><td></td><td></td><td></td><td></td><td></td><td></td></tr> <tr><td></td><td>270</td><td></td><td></td><td></td><td></td><td></td><td></td><td></td><td></td><td></td><td></td><td></td></tr> <tr><td></td><td>285</td><td></td><td></td><td></td><td></td><td></td><td></td><td></td><td></td><td></td><td></td><td></td></tr> <tr><td></td><td>300</td><td></td><td></td><td></td><td></td><td></td><td></td><td></td><td></td><td></td><td></td><td></td></tr> <tr><td></td><td>315</td><td></td><td></td><td></td><td></td><td></td><td></td><td></td><td></td><td></td><td></td><td></td></tr> </table>	1	330	■		■										345												0	0													15												2	30	■		■										45													60													75													90													105													120													135													150													165													180													195													210													225													240													255													270													285													300													315																							
1	330	■		■																																																																																																																																																																																																																																																																																																																																
	345																																																																																																																																																																																																																																																																																																																																			
0	0																																																																																																																																																																																																																																																																																																																																			
	15																																																																																																																																																																																																																																																																																																																																			
2	30	■		■																																																																																																																																																																																																																																																																																																																																
	45																																																																																																																																																																																																																																																																																																																																			
	60																																																																																																																																																																																																																																																																																																																																			
	75																																																																																																																																																																																																																																																																																																																																			
	90																																																																																																																																																																																																																																																																																																																																			
	105																																																																																																																																																																																																																																																																																																																																			
	120																																																																																																																																																																																																																																																																																																																																			
	135																																																																																																																																																																																																																																																																																																																																			
	150																																																																																																																																																																																																																																																																																																																																			
	165																																																																																																																																																																																																																																																																																																																																			
	180																																																																																																																																																																																																																																																																																																																																			
	195																																																																																																																																																																																																																																																																																																																																			
	210																																																																																																																																																																																																																																																																																																																																			
	225																																																																																																																																																																																																																																																																																																																																			
	240																																																																																																																																																																																																																																																																																																																																			
	255																																																																																																																																																																																																																																																																																																																																			
	270																																																																																																																																																																																																																																																																																																																																			
	285																																																																																																																																																																																																																																																																																																																																			
	300																																																																																																																																																																																																																																																																																																																																			
	315																																																																																																																																																																																																																																																																																																																																			
Version: 76																																																																																																																																																																																																																																																																																																																																				

Frontschild

S0.F025/A1B.PEL

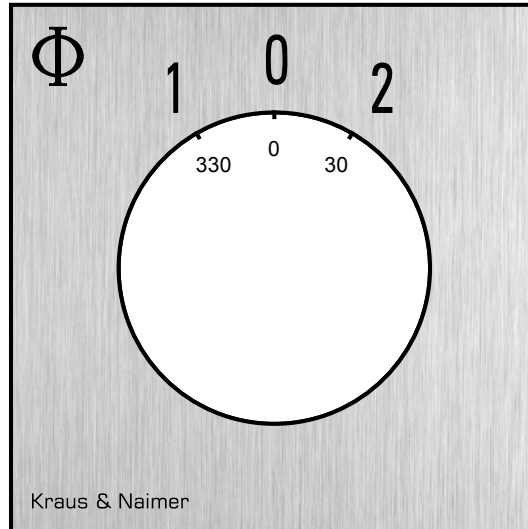

GRIFFE

Bezeichnung: S0C.G251

Grifffarbe: "1" schwarz

