

# Datenblatt | Artikelnummer: 282-901

2-Leiter-Durchgangsklemme; 6 mm<sup>2</sup>; mittige Beschriftung; für Tragschiene 35 x 15 und 35 x 7,5; CAGE CLAMP®; 6,00 mm<sup>2</sup>; grau

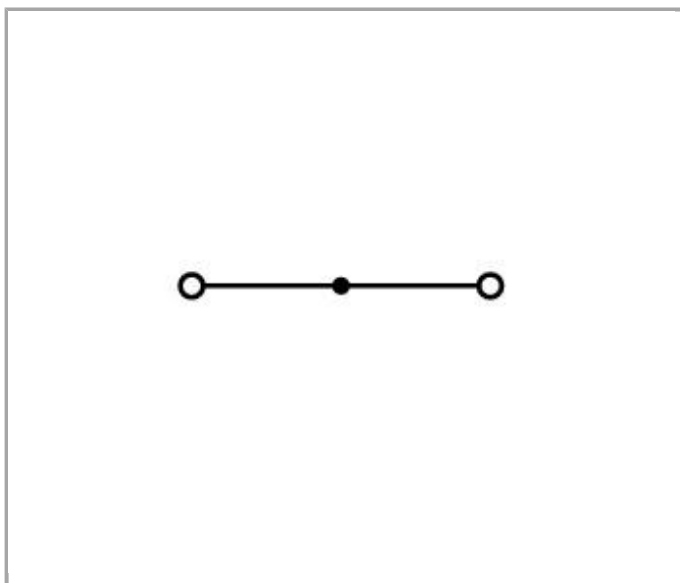

[www.wago.com/282-901](http://www.wago.com/282-901)

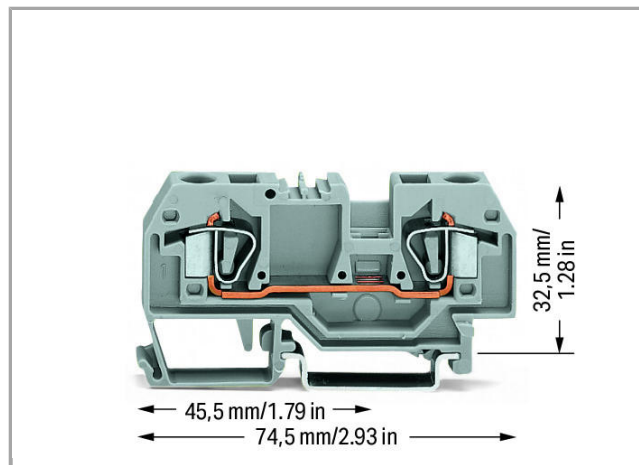
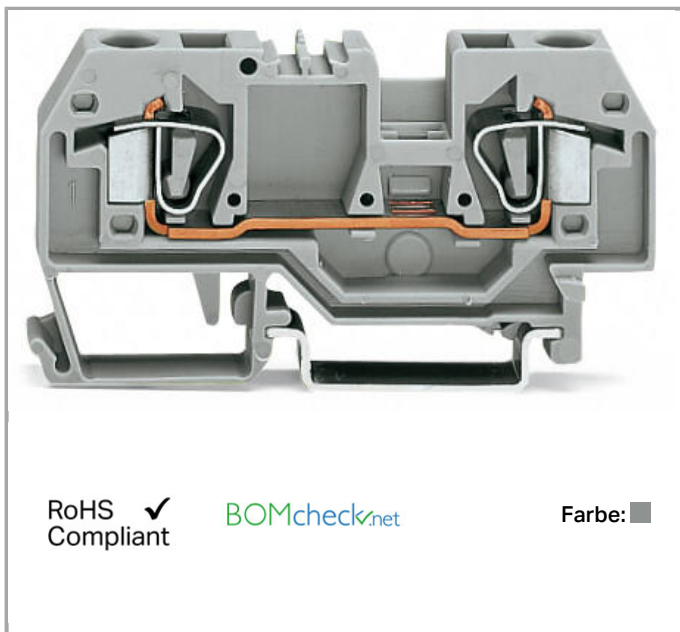

## Daten Elektrische Daten

### Bemessungsdaten gemäß IEC/EN 60664-1

Bemessungsspannung (III / 3)	800 V
Bemessungsstoßspannung (III / 3)	8 kV

Bemessungsstrom	41 A
-----------------	------

### Anschlussdaten

Anschluss technik	CAGE CLAMP®
Betätigungsart	Betätigungswerkzeug
Anschließbare Leiterwerkstoffe	Kupfer
Eindrähtiger Leiter	0,2 ... 6 mm <sup>2</sup> / 24 ... 10 AWG
Feindrähtiger Leiter	0,2 ... 6 mm <sup>2</sup> / 24 ... 10 AWG
Abisolierlänge	12 ... 13 mm / 0.47 ... 0.51 inch
Gesamte Anzahl der Klemmstellen	2
Gesamte Anzahl der Potentiale	1
Anzahl der Ebenen	1
Verdrahtungsart	Frontverdrahtung

### Geometrische Daten

Breite	8 mm / 0.315 inch
Höhe ab Oberkante Tragschiene	32,5 mm / 1.28 inch
Tiefe	74,5 mm / 2.933 inch

### Mechanische Daten

Bauform	horizontale Bauform
Montageart	Tragschiene 35
Beschriftungsebene	Mittenbeschriftung

### Werkstoffdaten



Farbe	grau
Isolierwerkstoff	Polyamid 66 (PA 66)
Brandlast	0.267 MJ
Gewicht	15.806 g

### Kaufmännische Daten

eCl@ss 10.0	27-14-11-20
eCl@ss 9.0	27-14-11-20
ETIM 7.0	EC000897
ETIM 6.0	EC000897
Ursprungsland	DE
GTIN	4044918445801
Zolltarifnummer	85369010000

## Zulassungen / Zertifikate

### Funk-Zulassungen

Logo	Zulassung	Norm	Zertifikatsname
	<b>CCA</b> DEKRA Certification B.V.	EN 60947	2195540.01
	<b>CCA</b> DEKRA Certification B.V.	EN 60947	NTR NL-7522

### Länderspezifische Zulassungen

Logo	Zulassung	Norm	Zertifikatsname
	<b>ABS</b> American Bureau of Shipping	EN 60947	14- HG1293677- PDA
	<b>BV</b> Bureau Veritas S.A.	EN 60947	07436/E0 BV
	<b>CCA</b> DEKRA Certification B.V.	EN 60947	2195540.01
	<b>CCA</b> DEKRA Certification B.V.	EN 60947	NTR NL-7522
	<b>CSA</b> DEKRA Certification B.V.	C22.2 No. 158	1505033
	<b>LR</b> Lloyds Register	EN 60947	91/20112 (E9)

### Schiff Zulassungen

Logo	Zulassung	Norm	Zertifikatsname
	<b>ABS</b> American Bureau of Shipping	EN 60947	14- HG1293677- PDA
	<b>BV</b> Bureau Veritas S.A.	EN 60947	07436/E0 BV



	<b>DNV GL</b> Det Norske Veritas, Germanischer Lloyd	-	TAE00001V2
--	---	---	------------



<b>LR</b> Lloyds Register	EN 60947	91/20112 (E9)
------------------------------	----------	---------------

#### Sonstige Zulassungen

Logo	Zulassung	Norm	Zertifikatsname
	<b>UL</b> UL International Germany GmbH	UL 1059	E45172

#### UL-Zulassungen

Logo	Zulassung	Norm	Zertifikatsname
	<b>UL</b> UL International Germany GmbH	UL 1059	E45172

#### Passende Produkte

##### Abdeckung



<b>Art-Nr.: 282-415</b> Warnabdeckung; mit schwarzem Blitzpfeil; für 5 Klemmen; gelb	<a href="http://www.wago.com/282-415">www.wago.com/282-415</a>
---	--

##### Prüfen und Messen







<b>Art-Nr.: 209-170</b> Prüfadapter; 8,3 mm breit; für Prüfstecker Ø 4 mm; passend für Klemmen 1,5 mm <sup>2</sup> - 10 mm <sup>2</sup> ; grau	<a href="http://www.wago.com/209-170">www.wago.com/209-170</a>
---	--

##### Werkzeug







<b>Art-Nr.: 210-721</b> Betätigungswerkzeug; Klinge 5,5 x 0,8 mm; mit teilisoliertem Schaft	<a href="http://www.wago.com/210-721">www.wago.com/210-721</a>
--	--









### Allgemeines Zubehör

	<b>Art-Nr.: 209-143</b> Gruppenschildträger	<a href="http://www.wago.com/209-143">www.wago.com/209-143</a>
	<b>Art-Nr.: 209-144</b> Gruppenschildträger	<a href="http://www.wago.com/209-144">www.wago.com/209-144</a>
	<b>Art-Nr.: 249-105</b> Gruppenschildträger	<a href="http://www.wago.com/249-105">www.wago.com/249-105</a>
	<b>Art-Nr.: 709-310</b> B-Prüfsteckermodule; anreihbar; passend zu allen WAGO-Reihenklempen der Serie 282 mit Brückerschlitzen; 6,00 mm <sup>2</sup> ; grau	<a href="http://www.wago.com/709-310">www.wago.com/709-310</a>
	<b>Art-Nr.: 709-311</b> B-Blindmodule; anreihbar; zum Überspringen von z. B. gebrückten Klempen; grau	<a href="http://www.wago.com/709-311">www.wago.com/709-311</a>

### Aderendhülse

	<b>Art-Nr.: 216-262</b> Aderendhülse; Hülse für 0,75 mm <sup>2</sup> / AWG 18; mit Kunststoffkragen; galvanisch verzinkt; Elektrolytkupfer; gasdicht aufgecrimpt; gemäß DIN 46228, Teil 4/09.90; grau	<a href="http://www.wago.com/216-262">www.wago.com/216-262</a>
	<b>Art-Nr.: 216-263</b> Aderendhülse; Hülse für 1 mm <sup>2</sup> / AWG 18; mit Kunststoffkragen; galvanisch verzinkt; Elektrolytkupfer; gasdicht aufgecrimpt; gemäß DIN 46228, Teil 4/09.90; rot	<a href="http://www.wago.com/216-263">www.wago.com/216-263</a>
	<b>Art-Nr.: 216-264</b> Aderendhülse; Hülse für 1,5 mm <sup>2</sup> / AWG 16; mit Kunststoffkragen; galvanisch verzinkt; Elektrolytkupfer; gasdicht aufgecrimpt; gemäß DIN 46228, Teil 4/09.90; schwarz	<a href="http://www.wago.com/216-264">www.wago.com/216-264</a>
	<b>Art-Nr.: 216-266</b> Aderendhülse; Hülse für 2,5 mm <sup>2</sup> / AWG 14; mit Kunststoffkragen; galvanisch verzinkt; Elektrolytkupfer; gasdicht aufgecrimpt; gemäß DIN 46228, Teil 4/09.90; blau	<a href="http://www.wago.com/216-266">www.wago.com/216-266</a>
	<b>Art-Nr.: 216-267</b> Aderendhülse; Hülse für 4 mm <sup>2</sup> / AWG 12; mit Kunststoffkragen; galvanisch verzinkt; Elektrolytkupfer; gasdicht aufgecrimpt; gemäß DIN 46228, Teil 4/09.90; grau	<a href="http://www.wago.com/216-267">www.wago.com/216-267</a>

### Brücker

	<b>Art-Nr.: 210-103</b> Drahtkettenbrücke; isoliert; 50 Anschlüsse; schwarz	<a href="http://www.wago.com/210-103">www.wago.com/210-103</a>
	<b>Art-Nr.: 210-123</b> Drahtkettenbrücke; isoliert; 50 Anschlüsse	<a href="http://www.wago.com/210-123">www.wago.com/210-123</a>
	<b>Art-Nr.: 282-402</b> Querbrücke; isoliert; Nennstrom 41 A; IN = IN Klemme; grau	<a href="http://www.wago.com/282-402">www.wago.com/282-402</a>
	<b>Art-Nr.: 282-409</b> Doppelteilungsquerbrücke; isoliert; Nennstrom 41 A; grau	<a href="http://www.wago.com/282-409">www.wago.com/282-409</a>
	<b>Art-Nr.: 282-422</b> Querbrücke; isoliert; Nennstrom 41 A; gelbgrün	<a href="http://www.wago.com/282-422">www.wago.com/282-422</a>
	<b>Art-Nr.: 282-424</b> Querbrücke; isoliert; Nennstrom 41 A; orange	<a href="http://www.wago.com/282-424">www.wago.com/282-424</a>
	<b>Art-Nr.: 284-413</b> Reduzierbrücke; isoliert; von 10/6 mm <sup>2</sup> auf 6/4 mm <sup>2</sup> ; Nennstrom 30 A; grau	<a href="http://www.wago.com/284-413">www.wago.com/284-413</a>
	<b>Art-Nr.: 284-414</b> Reduzierbrücke; isoliert; von 10/6 mm <sup>2</sup> auf 4/2,5/1,5 mm <sup>2</sup> ; Nennstrom 15 A; grau	<a href="http://www.wago.com/284-414">www.wago.com/284-414</a>



**Art-Nr.: 709-110**  
Drahtkettenbrücke; isoliert; 4 Anschlüsse; 3 x 110 mm; schwarz

[www.wago.com/709-110](http://www.wago.com/709-110)



**Art-Nr.: 709-111**  
Drahtkettenbrücke; isoliert; 3 Anschlüsse; 2 x 120 mm; schwarz

[www.wago.com/709-111](http://www.wago.com/709-111)



**Art-Nr.: 709-112**  
Drahtkettenbrücke; isoliert; 3 Anschlüsse; 2 x 170 mm; schwarz

[www.wago.com/709-112](http://www.wago.com/709-112)

#### Abschlussplatte



**Art-Nr.: 282-325**  
Abschluss- und Zwischenplatte; 2,5 mm dick; grau

[www.wago.com/282-325](http://www.wago.com/282-325)



**Art-Nr.: 282-326**  
Trennwand; 2 mm dick; überstehend; grau

[www.wago.com/282-326](http://www.wago.com/282-326)



**Art-Nr.: 282-328**  
Abschluss- und Zwischenplatte; 2,5 mm dick; orange

[www.wago.com/282-328](http://www.wago.com/282-328)



**Art-Nr.: 282-329**  
Trennwand; 2 mm dick; überstehend; orange

[www.wago.com/282-329](http://www.wago.com/282-329)



**Art-Nr.: 282-357**  
Reduzierabdeckplatte; 1 mm dick; in Verbindung mit 2-Leiter-Klemmen 282-901; grau

[www.wago.com/282-357](http://www.wago.com/282-357)



**Art-Nr.: 282-367**  
Reduzierabdeckplatte; 1 mm dick; in Verbindung mit 2-Leiter-Klemmen 282-901; orange

[www.wago.com/282-367](http://www.wago.com/282-367)

#### Montage



**Art-Nr.: 209-106**  
Haltebock; zur isolierten Montage von Tragschienen DIN 35; grau

[www.wago.com/209-106](http://www.wago.com/209-106)



**Art-Nr.: 709-153**  
Abdeckprofil; Typ 1; passend zu Abdeckprofilträger Typ 1; 1 m lang; transparent

[www.wago.com/709-153](http://www.wago.com/709-153)

#### Tragschiene



**Art-Nr.: 210-112**  
Stahltragschiene; 35 x 7,5 mm; 1 mm dick; 2 m lang; gelocht; entsprechend EN 60715; Lochbreite 25 mm; Lochabstand 36 mm

[www.wago.com/210-112](http://www.wago.com/210-112)



**Art-Nr.: 210-113**  
Stahltragschiene; 35 x 7,5 mm; 1 mm dick; 2 m lang; ungelocht; entsprechend EN 60715

[www.wago.com/210-113](http://www.wago.com/210-113)



**Art-Nr.: 210-114**  
Stahltragschiene; 35 x 15 mm; 1,5 mm dick; 2 m lang; ungelocht; ähnlich EN 60715

[www.wago.com/210-114](http://www.wago.com/210-114)



**Art-Nr.: 210-115**  
Stahltragschiene; 35 x 7,5 mm; 1 mm dick; 2 m lang; gelocht; entsprechend EN 60715; Lochbreite 18 mm; Lochabstand 25 mm

[www.wago.com/210-115](http://www.wago.com/210-115)



**Art-Nr.: 210-118**  
Stahltragschiene; 35 x 15 mm; 2,3 mm dick; 2 m lang; ungelocht; entsprechend EN 60715

[www.wago.com/210-118](http://www.wago.com/210-118)



**Art-Nr.: 210-196**  
Aluminiumtragschiene; 35 x 8,2 mm; 1,6 mm dick; 2 m lang; ungelocht; ähnlich EN 60715; silberfarben

















[www.wago.com/210-196](http://www.wago.com/210-196)



**Art-Nr.: 210-197**  
Stahltragschiene; 35 x 15 mm; 1,5 mm dick; 2 m lang; gelocht; ähnlich EN 60715

[www.wago.com/210-197](http://www.wago.com/210-197)

**Art-Nr.: 210-198**

	Kupfertragschiene; 35 x 15 mm; 2,3 mm dick; 2 m lang; ungelocht; entsprechend EN 60715; kupferfarben	<a href="http://www.wago.com/210-198">www.wago.com/210-198</a>
	<b>Art-Nr.: 210-504</b> Stahltragschiene; 35 x 7,5 mm; 1 mm dick; 2 m lang; gelocht; bandverzinkt; entsprechend EN 60715	<a href="http://www.wago.com/210-504">www.wago.com/210-504</a>
	<b>Art-Nr.: 210-505</b> Stahltragschiene; 35 x 7,5 mm; 1 mm dick; 2 m lang; ungelocht; bandverzinkt; entsprechend EN 60715	<a href="http://www.wago.com/210-505">www.wago.com/210-505</a>
	<b>Art-Nr.: 210-506</b> Stahltragschiene; 35 x 15 mm; 1,5 mm dick; 2 m lang; ungelocht; bandverzinkt; ähnlich EN 60715	<a href="http://www.wago.com/210-506">www.wago.com/210-506</a>
	<b>Art-Nr.: 210-508</b> Stahltragschiene; 35 x 15 mm; 1,5 mm dick; 2 m lang; gelocht; bandverzinkt; ähnlich EN 60715	<a href="http://www.wago.com/210-508">www.wago.com/210-508</a>
<b>Beschriftungsmaterial</b>		
	<b>Art-Nr.: 2009-115</b> WMB-Inline; für Smart Printer; auf Rolle; dehnbar 5 - 5,2 mm; unbedruckt; aufrastbar; weiß	<a href="http://www.wago.com/2009-115">www.wago.com/2009-115</a>
	<b>Art-Nr.: 2009-115/000-002</b> WMB-Inline; für Smart Printer; auf Rolle; dehnbar 5 - 5,2 mm; unbedruckt; aufrastbar; gelb	<a href="http://www.wago.com/2009-115/000-002">www.wago.com/2009-115/000-002</a>
	<b>Art-Nr.: 2009-115/000-006</b> WMB-Inline; für Smart Printer; auf Rolle; dehnbar 5 - 5,2 mm; unbedruckt; aufrastbar; blau	<a href="http://www.wago.com/2009-115/000-006">www.wago.com/2009-115/000-006</a>
	<b>Art-Nr.: 2009-115/000-007</b> WMB-Inline; für Smart Printer; auf Rolle; dehnbar 5 - 5,2 mm; unbedruckt; aufrastbar; grau	<a href="http://www.wago.com/2009-115/000-007">www.wago.com/2009-115/000-007</a>
	<b>Art-Nr.: 2009-115/000-012</b> WMB-Inline; für Smart Printer; auf Rolle; dehnbar 5 - 5,2 mm; unbedruckt; aufrastbar; orange	<a href="http://www.wago.com/2009-115/000-012">www.wago.com/2009-115/000-012</a>
	<b>Art-Nr.: 2009-115/000-017</b> WMB-Inline; für Smart Printer; auf Rolle; dehnbar 5 - 5,2 mm; unbedruckt; aufrastbar; hellgrün	<a href="http://www.wago.com/2009-115/000-017">www.wago.com/2009-115/000-017</a>
	<b>Art-Nr.: 2009-115/000-023</b> WMB-Inline; für Smart Printer; auf Rolle; dehnbar 5 - 5,2 mm; unbedruckt; aufrastbar; grün	<a href="http://www.wago.com/2009-115/000-023">www.wago.com/2009-115/000-023</a>
	<b>Art-Nr.: 2009-115/000-024</b> WMB-Inline; für Smart Printer; auf Rolle; dehnbar 5 - 5,2 mm; unbedruckt; aufrastbar; violett	<a href="http://www.wago.com/2009-115/000-024">www.wago.com/2009-115/000-024</a>
	<b>Art-Nr.: 209-185</b> Adapter	<a href="http://www.wago.com/209-185">www.wago.com/209-185</a>
	<b>Art-Nr.: 210-612</b> Beschriftungstreifen; zum Selbstbeschriften; unbedruckt; Selbstklebend; transparent	<a href="http://www.wago.com/210-612">www.wago.com/210-612</a>
	<b>Art-Nr.: 793-501</b> WMB-Beschriftungskarte; als Karte; nicht dehnbar; unbedruckt; aufrastbar; weiß	<a href="http://www.wago.com/793-501">www.wago.com/793-501</a>
	<b>Art-Nr.: 793-501/000-002</b> WMB-Beschriftungskarte; als Karte; nicht dehnbar; unbedruckt; aufrastbar; weiß	<a href="http://www.wago.com/793-501/000-002">www.wago.com/793-501/000-002</a>



**Art-Nr.: 793-501/000-005**  
WMB-Beschriftungskarte; als Karte; nicht dehnbar; unbedruckt; aufrastbar; weiß

[www.wago.com/793-501/000-005](http://www.wago.com/793-501/000-005)



**Art-Nr.: 793-501/000-006**  
WMB-Beschriftungskarte; als Karte; nicht dehnbar; unbedruckt; aufrastbar; weiß

[www.wago.com/793-501/000-006](http://www.wago.com/793-501/000-006)



**Art-Nr.: 793-501/000-007**  
WMB-Beschriftungskarte; als Karte; nicht dehnbar; unbedruckt; aufrastbar; weiß

[www.wago.com/793-501/000-007](http://www.wago.com/793-501/000-007)



**Art-Nr.: 793-501/000-012**  
WMB-Beschriftungskarte; als Karte; nicht dehnbar; unbedruckt; aufrastbar; weiß

[www.wago.com/793-501/000-012](http://www.wago.com/793-501/000-012)



**Art-Nr.: 793-501/000-017**  
WMB-Beschriftungskarte; als Karte; nicht dehnbar; unbedruckt; aufrastbar; weiß

[www.wago.com/793-501/000-017](http://www.wago.com/793-501/000-017)



**Art-Nr.: 793-501/000-023**  
WMB-Beschriftungskarte; als Karte; nicht dehnbar; unbedruckt; aufrastbar; weiß

[www.wago.com/793-501/000-023](http://www.wago.com/793-501/000-023)



**Art-Nr.: 793-501/000-024**  
WMB-Beschriftungskarte; als Karte; nicht dehnbar; unbedruckt; aufrastbar; weiß

[www.wago.com/793-501/000-024](http://www.wago.com/793-501/000-024)



**Art-Nr.: 793-5501**  
WMB-Beschriftungskarte; als Karte; für Klemmenbreite 5 - 17,5 mm; dehnbar 5 - 5,2 mm; unbedruckt; aufrastbar; weiß

[www.wago.com/793-5501](http://www.wago.com/793-5501)



**Art-Nr.: 793-5501/000-002**  
WMB-Beschriftungskarte; als Karte; für Klemmenbreite 5 - 17,5 mm; dehnbar 5 - 5,2 mm; unbedruckt; aufrastbar; gelb

[www.wago.com/793-5501/000-002](http://www.wago.com/793-5501/000-002)



**Art-Nr.: 793-5501/000-005**  
WMB-Beschriftungskarte; als Karte; dehnbar 5 - 5,2 mm; unbedruckt; aufrastbar; rot

[www.wago.com/793-5501/000-005](http://www.wago.com/793-5501/000-005)



**Art-Nr.: 793-5501/000-006**  
WMB-Beschriftungskarte; als Karte; dehnbar 5 - 5,2 mm; unbedruckt; aufrastbar; blau

[www.wago.com/793-5501/000-006](http://www.wago.com/793-5501/000-006)



**Art-Nr.: 793-5501/000-007**  
WMB-Beschriftungskarte; als Karte; dehnbar 5 - 5,2 mm; unbedruckt; aufrastbar; grau

[www.wago.com/793-5501/000-007](http://www.wago.com/793-5501/000-007)



**Art-Nr.: 793-5501/000-012**  
WMB-Beschriftungskarte; als Karte; dehnbar 5 - 5,2 mm; unbedruckt; aufrastbar; orange

[www.wago.com/793-5501/000-012](http://www.wago.com/793-5501/000-012)



**Art-Nr.: 793-5501/000-014**  
WMB-Beschriftungskarte; als Karte; dehnbar 5 - 5,2 mm; unbedruckt; aufrastbar; braun

[www.wago.com/793-5501/000-014](http://www.wago.com/793-5501/000-014)



**Art-Nr.: 793-5501/000-017**  
WMB-Beschriftungskarte; als Karte; dehnbar 5 - 5,2 mm; unbedruckt; aufrastbar; hellgrün

[www.wago.com/793-5501/000-017](http://www.wago.com/793-5501/000-017)



Art-Nr.: 793-5501/000-023

WMB-Beschriftungskarte; als Karte; dehnbar 5 - 5,2 mm; unbedruckt; aufrastbar; grün

[www.wago.com/793-5501/000-023](http://www.wago.com/793-5501/000-023)



Art-Nr.: 793-5501/000-024

WMB-Beschriftungskarte; als Karte; dehnbar 5 - 5,2 mm; unbedruckt; aufrastbar; violett

[www.wago.com/793-5501/000-024](http://www.wago.com/793-5501/000-024)

## Downloads

### Dokumentation

#### Ausschreibungstext

282-901		doc 24,6 kB	Download
---------	--	----------------	----------

#### Weitere Informationen

Technische Erläuterungen	03.04.2019	pdf 2,1 MB	Download
--------------------------	------------	---------------	----------

## CAD/CAE - Smart Data

### CAD Daten

3D Download 282-901		URL	Download
---------------------	--	-----	----------

### EPLAN

EPLAN Data Portal			Download
-------------------	--	--	----------

### WSCAD

WSCAD Universe			Download
----------------	--	--	----------

Änderungen vorbehalten.