



Symbolbild

Datenblatt





Artikelnummer: 70018742

Bezeichnung: CA20.A201*A-V751.PNL4

Beschreibung: Schalter

IEC 60947-3 EN 60947-3, VDE 0660 Teil 107						
Bemessungsisolationsspannung Ui						
			Spannung (V) AC / DC			
			690 AC / DC			
Bemessungsdauerstrom Iu/lth						
Strom (A)		Umgebungstemperatur (°C)		Temperaturspitzen (°C) zusätzliche Bedingungen		
25		55		60 Umgebungstemperatur +55°C über 24 Stunden mit Spitzen bis +60°C		
Bemessungsbetriebsstrom Ie						
Gebrauchskategorie			Spannung (V)		Strom (A)	
AC-15			220 - 240		8	
AC-15			380 - 440		5	
Bemessungsbetriebsleistung						
Gebrauchskategorie		Spannung (V)	Phasenanzahl	Polanzahl	Leistung (kW)	
AC-3		220 - 240	3	3	4	
AC-3		380 - 440	3	3	7,50	
AC-3		660 - 690	3	3	7,50	
AC-3		220 - 240	1	2	3	
AC-3		380 - 440	1	2	3,70	
AC-23A		220 - 240	3	3	5,50	
AC-23A		380 - 440	3	3	11	
AC-23A		660 - 690	3	3	11	
AC-23A		220 - 240	1	2	3	
AC-23A		380 - 440	1	2	5,50	
Max. Sicherungsnennstrom IEC						
Sicherungscharakteristik			Sicherungsanzahl		Strom (A)	
gG			1		35	
UL60947-4-1 , UL508						
Nominal Voltage						
			Spannung (V) AC / DC			
			600 AC			
Bemessungsisolationsspannung Ui						
			Spannung (V) AC / DC			
			600 AC			
Rated thermal current						
		Strom (A)		Umgebungstemperatur (°C) Zusatz Text		
		30		0 - 40 --		
Horsepower rating						
Across-the-Line Motor Starting		Spannung (V)	Phasenanzahl	Polanzahl	Leistung (HP)	Umgebungstemperatur [°C]
Reversing		110 - 120	1	2	0,33	40
Reversing		220 - 240	1	2	0,75	40
Reversing		277 - 277	1	2	1	40
Reversing		415 - 415	1	2	1,50	40
Reversing		440 - 480	1	2	2	40
Reversing		550 - 600	1	2	2	40
Reversing		110 - 120	3	3	1	40
Reversing		220 - 240	3	3	2	40
Reversing		415 - 415	3	3	3	40
Reversing		440 - 480	3	3	5	40
Reversing		550 - 600	3	3	5	40
DOL		110 - 120	1	2	1,50	40
DOL		220 - 240	1	2	3	40
DOL		277 - 277	1	2	3	40
DOL		415 - 415	1	2	3	40
DOL		440 - 480	1	2	5	40
DOL		550 - 600	1	2	5	40
DOL		110 - 120	3	3	3	40
DOL		220 - 240	3	3	7,50	40
DOL		415 - 415	3	3	7,50	40
DOL		440 - 480	3	3	10	40

Horsepower rating						
<i>Across-the-Line Motor Starting</i>						
DOL	Spannung (V)	Phasenanzahl	Polanzahl	Leistung (HP)	Umgebungstemperatur [°C]	
	550 - 600	3	3	10	40	
Pilot duty rating code						
<i>Duty Code</i>						
A600						
SCCR / Max. Vorsicherung						
<i>Conditions of acceptability</i>						
These devices are suitable for use on circuits capable of delivering not more than 5000 rms symmetrical amperes, 600V ac max. when protected by Class RK1 fuses. Manual Motor Controllers when intended for use as a motor disconnect are suitable for use on a circuit capable of delivering not more than 5000 rms symmetrical amperes, 600V ac max. when protected by 30A Class J time delay fuses.						
Temp. rating of wire						
Temperature Rating (°C)			Strom (A) Text			
75			– Use copper wire only			
Anschlussbestimmungen						
<i>Markings</i>						
When intended for use as a motor disconnect the device shall be provided with a method of being locked in the OFF-position.						
General Use						
AC / DC	Spannung (V)	Strom (A)	Phasenanzahl	Polanzahl	Anzahl der Kontakte in Serie	
AC	600	30	1	2	1	
AC	600	30	3	3	1	
CSA						
Nominal Voltage						
			Spannung (V) AC / DC			
			600 AC			
Bemessungsisolationsspannung Ui						
			Spannung (V) AC / DC			
			600 AC			
Rated thermal current						
		Strom (A)		Umgebungstemperatur (°C) Zusatz Text		
		30		0 - 40 –		
Horsepower rating						
<i>Across-the-Line Motor Starting</i>						
DOL	Spannung (V)	Phasenanzahl	Polanzahl	Leistung (HP)	Umgebungstemperatur [°C]	
DOL	110 - 120	1	2	1,50	40	
DOL	220 - 240	1	2	3	40	
DOL	277 - 277	1	2	3	40	
DOL	415 - 415	1	2	5	40	
DOL	440 - 480	1	2	5	40	
DOL	550 - 600	1	2	5	40	
DOL	110 - 120	3	3	3	40	
DOL	220 - 240	3	3	7,50	40	
DOL	415 - 415	3	3	10	40	
DOL	440 - 480	3	3	10	40	
DOL	550 - 600	3	3	10	40	
Pilot duty rating code						
<i>Duty Code</i>						
A600						
Temp. rating of wire						
Temperature Rating (°C)			Strom (A) Text			
75			– only			
General Use						
AC / DC	Spannung (V)	Strom (A)	Phasenanzahl	Polanzahl	Anzahl der Kontakte in Serie	
AC	600	30	1	1	1	
GENERAL TECHNICAL INFORMATION						
Leiterquerschnitt						
<i>Leiteraufbau</i>	<i>Min. / Max. Wert</i>		<i>Anzahl der Leiter pro Klemme</i>	<i>Drahtquerschnitt (-bereich) (mm²) oder (AWG/kcmil)</i>	<i>Drahtmaterial</i>	
eindräftig	Min.		1	0,75mm ²	Kupfer	
eindräftig	Min.		2	0,75mm ²	Kupfer	
feindräftig	Min.		1	1,5mm ²	Kupfer	
feindräftig	Max.		2	AWG 12	Kupfer	
feindräftig	Max.		2	4mm ²	Kupfer	
feindräftig	Min.		2	1,5mm ²	Kupfer	
ein- bzw. mehrdräftig	Max.		2	AWG 10	Kupfer	
ein- bzw. mehrdräftig	Max.		2	4mm ²	Kupfer	
feindräftig mit Aderendhülsen nach DIN 46228	Min.		1	1mm ²	Kupfer	
feindräftig mit Aderendhülsen nach DIN 46228	Max.		2	2,5mm ²	Kupfer	
feindräftig mit Aderendhülsen nach DIN 46228	Min.		2	1mm ²	Kupfer	
Abisolierlänge des Leiters						
			Länge (mm) Anschlusslänge - Bild			
						
Empfohlene Schraubendreher						
<i>Schraubendreherart</i>			Wert			
Kreuzschlitz - Schraubendreher			PH1			
Schlitzschraubendreher nach DIN 5264			0,8x5,5			
Klemmschraube						
			Anzugsdrehmoment (Nm)		Anzugsdrehmoment (lb-in)	
			1		9	

Approbationen	Marking
Specification	
EAC	
CE marking	
UK Directives	
CSA C.22.2 No.14	
GB/T14048.3	

Allgemeine Informationen
Text
<ul style="list-style-type: none"> - Die Schaltgeräte sind wartungsfrei. Schmierung oder Behandlung von Kontakten ist zu unterlassen. - Die Schalter dürfen nur von Fachkräften und nach den anerkannten Regeln der Technik eingebaut, angeschlossen und in Betrieb genommen werden. - Nur Kupferleitungen verwenden. Leiterenden nicht verzinnen. - Klemmen mit werkseitig angeschlossenen Verbindungslaschen bzw. Drahtverbindungen werden verschraubt geliefert. Nach dem Öffnen solcher Klemmen ist darauf zu achten, dass keine Verbindungslaschen verloren gehen, alle Drahtverbindungen wieder korrekt sitzen und die Klemmschrauben mit dem angegebenen Drehmoment wieder festgezogen werden. - Nach Installation der Schalter müssen die Kriech- und Luftstrecken im Bereich der Anschlussklemmen den Anforderungen der anwendbaren Norm und Vorschriften entsprechen.

Waste Electrical & Electronic Equipment (WEEE)	
Picture name	Description
	Nicht in den Müll werfen, da auf eine umweltgerechte Entsorgung und Wiederverwertung geachtet werden muss. Bitte wenden Sie sich entweder an ein umweltfreundliches Entsorgungsunternehmen; senden Sie es zur Entsorgung an den Lieferanten oder direkt an den Hersteller Kraus & Naimer zurück. Lokale Kraus & Naimer Ansprechpartner finden Sie unter www.krausnaimer.com

Proposition 65	
Bildname	Beschreibung
	WARNING: This product can expose you to chemicals including nickel and lead, which is known to the State of California to cause cancer. For more information go to www.P65Warnings.ca.gov .

Kontakttype: Starre Kontaktbrücke
Kontaktmaterial: Silber
Anschluss: Schraubanschluss

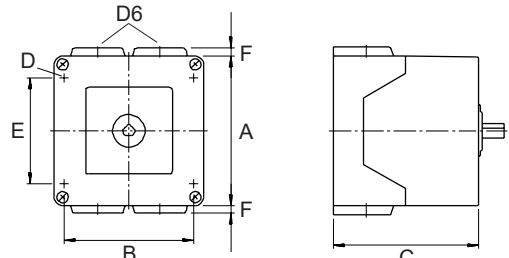
Bauform-PNL4	
	
IP - Schutzart Front	IP42
Fluchten	1,00 - 2,00
A	□ 82,00 mm
B	H 68,00 mm
C	H 59,70 mm
D	∅ 4,40 mm
D6	∅ 4,00 x M25
E	H 52,00 mm
F	H 5,00 mm

Anschlussbild

CA20.A201.PNL4

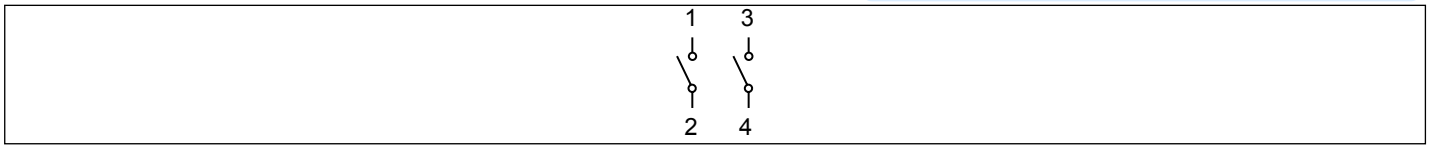

Schaltprogramm

CA20.A201.PNL4

 Kraus & Naimer

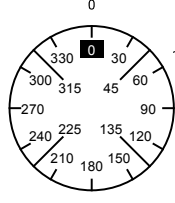
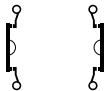
	CA20	A201	Seite 1 von 1											
Frontschild														
	1	3	5	7	9	11	13	15	17	19	21	23		
														
Schaltwinkel <input type="text" value="60"/>	2	4	6	8	10	12	14	16	18	20	22	24		
Gesamtschaltwinkel <input type="text" value="60"/>														
0	0													
	15													
	30													
	45													
1	60													
	75													
	90													
	105													
	120													
	135													
	150													
	165													
	180													
	195													
	210													
	225													
	240													
	255													
	270													
	285													
	300													
	315													
	330													
	345													

Version: 121

Frontschild

S1.F070/A10.V45

