







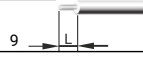

Symbolbild

## Datenblatt

**Artikelnummer:** 70005384  
**Bezeichnung:** CA20.A222.PNL4  
**Beschreibung:** Schalter

IEC 60947-3 EN 60947-3, VDE 0660 Teil 107						
<b>Bemessungsisolationsspannung Ui</b>						
			Spannung (V) AC / DC			
			690 AC / DC			
<b>Bemessungsdauerstrom Iu/Ith</b>						
Strom (A)	Umgebungstemperatur (°C)	Temperaturspitzen (°C)	zusätzliche Bedingungen			
25	55	60	Umgebungstemperatur +55°C über 24 Stunden mit Spitzen bis +60°C			
<b>Bemessungsbetriebsstrom Ie</b>						
Gebrauchskategorie		Spannung (V)			Strom (A)	
AC-15		220 - 240			8	
AC-15		380 - 440			5	
<b>Bemessungsbetriebsleistung</b>						
Gebrauchskategorie	Spannung (V)	Phasenanzahl	Polanzahl	Leistung (kW)		
AC-3	220 - 240	3	3	4		
AC-3	380 - 440	3	3	7,50		
AC-3	660 - 690	3	3	7,50		
AC-3	220 - 240	1	2	3		
AC-3	380 - 440	1	2	3,70		
AC-23A	220 - 240	3	3	5,50		
AC-23A	380 - 440	3	3	11		
AC-23A	660 - 690	3	3	11		
AC-23A	220 - 240	1	2	3		
AC-23A	380 - 440	1	2	5,50		
<b>Max. Sicherungsnennstrom IEC</b>						
Sicherungscharakteristik		Sicherungsanzahl			Strom (A)	
gG		1			35	
<b>UL60947-4-1 , UL508</b>						
<b>Nominal Voltage</b>						
			Spannung (V) AC / DC			
			600 AC			
<b>Bemessungsisolationsspannung Ui</b>						
			Spannung (V) AC / DC			
			600 AC			
<b>Rated thermal current</b>						
		Strom (A)	Umgebungstemperatur (°C)		Zusatz Text	
		30	0 - 40		-	
<b>Horsepower rating</b>						
Across-the-Line Motor Starting		Spannung (V)	Phasenanzahl	Polanzahl	Leistung (HP)	Umgebungstemperatur [°C]
Reversing		110 - 120	1	2	0,33	40
Reversing		220 - 240	1	2	0,75	40
Reversing		277 - 277	1	2	1	40
Reversing		415 - 415	1	2	1,50	40
Reversing		440 - 480	1	2	2	40
Reversing		550 - 600	1	2	2	40
Reversing		110 - 120	3	3	1	40
Reversing		220 - 240	3	3	2	40
Reversing		415 - 415	3	3	3	40
Reversing		440 - 480	3	3	5	40
Reversing		550 - 600	3	3	5	40
DOL		110 - 120	1	2	1,50	40
DOL		220 - 240	1	2	3	40
DOL		277 - 277	1	2	3	40
DOL		415 - 415	1	2	3	40
DOL		440 - 480	1	2	5	40
DOL		550 - 600	1	2	5	40
DOL		110 - 120	3	3	3	40
DOL		220 - 240	3	3	7,50	40
DOL		415 - 415	3	3	7,50	40
DOL		440 - 480	3	3	10	40
DOL		550 - 600	3	3	10	40

<b>Pilot duty rating code</b>						
Duty Code						
A600						
<b>SCCR / Max. Vorsicherung</b>						
Conditions of acceptability						
These devices are suitable for use on circuits capable of delivering not more than 5000 rms symmetrical amperes, 600V ac max. when protected by Class RK1 fuses. Manual Motor Controllers when intended for use as a motor disconnect are suitable for use on a circuit capable of delivering not more than 5000 rms symmetrical amperes, 600V ac max. when protected by 30A Class J time delay fuses.						
<b>Temp. rating of wire</b>						
Temperature Rating (°C)			Strom (A) Text			
75			– Use copper wire only			
<b>Anschlussbestimmungen</b>						
Markings						
When intended for use as a motor disconnect the device shall be provided with a method of being locked in the OFF-position.						
<b>General Use</b>						
AC / DC	Spannung (V)	Strom (A)	Phasenanzahl	Polanzahl	Anzahl der Kontakte in Serie	
AC	600	30	1	2	1	
AC	600	30	3	3	1	
<b>CSA</b>						
<b>Nominal Voltage</b>						
			Spannung (V) AC / DC			
			600 AC			
<b>Bemessungsisolationsspannung Ui</b>						
			Spannung (V) AC / DC			
			600 AC			
<b>Rated thermal current</b>						
		Strom (A)		Umgebungstemperatur (°C) Zusatz Text		
		30		0 - 40 –		
<b>Horsepower rating</b>						
Across-the-Line Motor Starting						
	Spannung (V)	Phasenanzahl	Polanzahl	Leistung (HP)	Umgebungstemperatur [°C]	
DOL	110 - 120	1	2	1,50	40	
DOL	220 - 240	1	2	3	40	
DOL	277 - 277	1	2	3	40	
DOL	415 - 415	1	2	5	40	
DOL	440 - 480	1	2	5	40	
DOL	550 - 600	1	2	5	40	
DOL	110 - 120	3	3	3	40	
DOL	220 - 240	3	3	7,50	40	
DOL	415 - 415	3	3	10	40	
DOL	440 - 480	3	3	10	40	
DOL	550 - 600	3	3	10	40	
<b>Pilot duty rating code</b>						
Duty Code						
A600						
<b>Temp. rating of wire</b>						
Temperature Rating (°C)			Strom (A) Text			
75			– only			
<b>General Use</b>						
AC / DC	Spannung (V)	Strom (A)	Phasenanzahl	Polanzahl	Anzahl der Kontakte in Serie	
AC	600	30	1	1	1	
<b>GENERAL TECHNICAL INFORMATION</b>						
<b>Leiterquerschnitt</b>						
Leiteraufbau	Min. / Max. Wert	Anzahl der Leiter pro Klemme		Drahtquerschnitt (-bereich) (mm <sup>2</sup> ) oder (AWG/kcmil)	Drahtmaterial	
eindräftig	Min.			1 0,75mm <sup>2</sup>	Kupfer	
eindräftig	Min.			2 0,75mm <sup>2</sup>	Kupfer	
feindräftig	Min.			1 1,5mm <sup>2</sup>	Kupfer	
feindräftig	Max.			2 AWG 12	Kupfer	
feindräftig	Max.			2 4mm <sup>2</sup>	Kupfer	
feindräftig	Min.			2 1,5mm <sup>2</sup>	Kupfer	
ein- bzw. mehrdräftig	Max.			2 AWG 10	Kupfer	
ein- bzw. mehrdräftig	Max.			2 4mm <sup>2</sup>	Kupfer	
feindräftig mit Aderendhülsen nach DIN 46228	Min.			1 1mm <sup>2</sup>	Kupfer	
feindräftig mit Aderendhülsen nach DIN 46228	Max.			2 2,5mm <sup>2</sup>	Kupfer	
feindräftig mit Aderendhülsen nach DIN 46228	Min.			2 1mm <sup>2</sup>	Kupfer	
<b>Abisolierlänge des Leiters</b>						
			Länge (mm) Anschlusslänge - Bild			
						
<b>Empfohlene Schraubendreher</b>						
Schraubendreherart			Wert			
Kreuzschlitz - Schraubendreher			PH1			
Schlitzschraubendreher nach DIN 5264			0,8x5,5			
<b>Klemmschraube</b>						
			Anzugsdrehmoment (Nm)		Anzugsdrehmoment (lb-in)	
			1		9	
<b>Approbationen</b>						
Specification						Marking
EAC						

Approbationen	Marking
Specification	
CE marking	
UK Directives	
CSA C.22.2 No.14	
GB/T14048.3	

Allgemeine Informationen
Text
<ul style="list-style-type: none"> <li>- Die Schaltgeräte sind wartungsfrei. Schmierung oder Behandlung von Kontakten ist zu unterlassen.</li> <li>- Die Schalter dürfen nur von Fachkräften und nach den anerkannten Regeln der Technik eingebaut, angeschlossen und in Betrieb genommen werden.</li> <li>- Nur Kupferleitungen verwenden. Leiterenden nicht verzinnen.</li> <li>- Klemmen mit werkseitig angeschlossenen Verbindungslaschen bzw. Drahtverbindungen werden verschraubt geliefert. Nach dem Öffnen solcher Klemmen ist darauf zu achten, dass keine Verbindungslaschen verloren gehen, alle Drahtverbindungen wieder korrekt sitzen und die Klemmschrauben mit dem angegebenen Drehmoment wieder festgezogen werden.</li> <li>- Nach Installation der Schalter müssen die Kriech- und Luftstrecken im Bereich der Anschlussklemmen den Anforderungen der anwendbaren Norm und Vorschriften entsprechen.</li> </ul>

Waste Electrical & Electronic Equipment (WEEE)	
Picture name	Description
	Nicht in den Müll werfen, da auf eine umweltgerechte Entsorgung und Wiederverwertung geachtet werden muss. Bitte wenden Sie sich entweder an ein umweltfreundliches Entsorgungsunternehmen, senden Sie es zur Entsorgung an den Lieferanten oder direkt an den Hersteller Kraus & Naimer zurück. Lokale Kraus & Naimer Ansprechpartner finden Sie unter <a href="http://www.krausnaimer.com">www.krausnaimer.com</a>

Proposition 65	
Bildname	Beschreibung
	WARNING: This product can expose you to chemicals including nickel and lead, which is known to the State of California to cause cancer. For more information go to <a href="http://www.P65Warnings.ca.gov">www.P65Warnings.ca.gov</a> .

Kontakttype: Starre Kontaktbrücke
Kontaktmaterial: Silber
Anschluss: Schraubanschluss

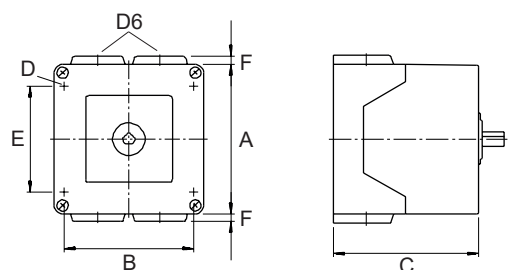
Bauform-PNL4	
	
IP - Schutzart Front	IP42
Fluchten	3,00 - 4,00
A	□ 82,00 mm
B	H 68,00 mm
C	H 85,10 mm
D	∅ 4,40 mm
D6	∅ 4,00 x M25
E	H 52,00 mm
F	H 5,00 mm

## Anschlussbild

CA20.A222.PNL4

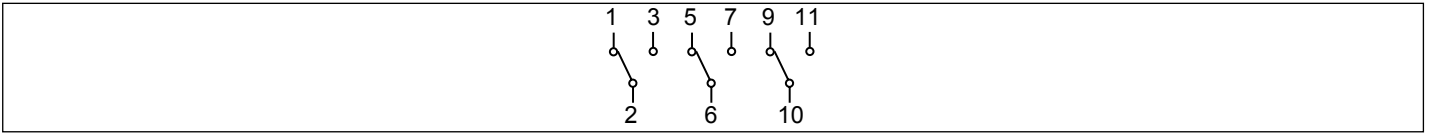

# Schaltprogramm

CA20.A222.PNL4

 Kraus & Naimer

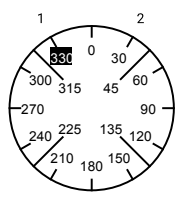
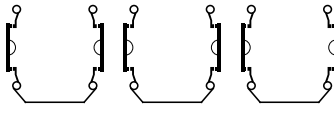
		CA20				A222				Seite 1 von 1			
<b>Frontschild</b>													
		1	3	5	7	9	11	13	15	17	19	21	23
													
Schaltwinkel <input type="text" value="60"/> Gesamtschaltwinkel <input type="text" value="60"/>		2	4	6	8	10	12	14	16	18	20	22	24
1	330	■		■		■							
	345												
	0												
	15												
2	30	■		■		■							
	45												
	60												
	75												
	90												
	105												
	120												
	135												
	150												
	165												
	180												
	195												
	210												
	225												
	240												
	255												
	270												
	285												
	300												
	315												

Version: 115

**Frontschild**

S1.F072/A10.PNL

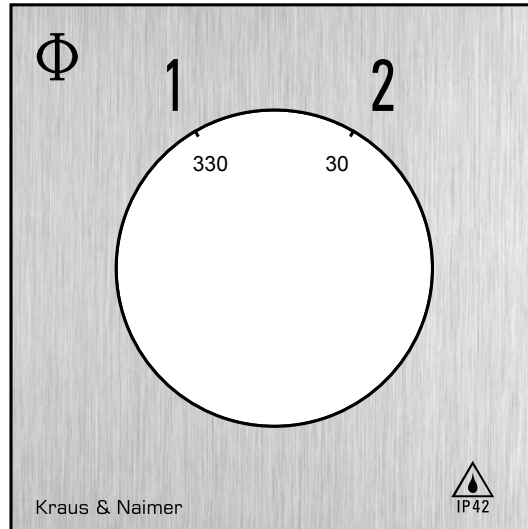

## GRIFFE

**Bezeichnung:** S1B.G257

**Grifffarbe:** "7" elektro grau

